

LUXPOWER® SERIES 5 530-550W Mono

M10/182mm Cell . 144 Half-Cell Layout

LUXPOWER® Series 5 solar modules stand out with the breakthrough innovation of M10 size (182mm) solar cells for the highest power generation and the lowest LCOE, which makes Series 5 the optimal choice for large solar power plants. The gallium-doped wafer technology empowers significantly the performance against LID and the latest integrated segmented ribbon technology increases the power output and enhances the module reliability for long-term use.



Gallium-doped Technology



Half Cut Cell Technology



MBB Technology



Anti-PID
Low LID
Performance



Less Hot Spot
Shading Effects



Lower BOS & LCOE

Linear performance Warranty

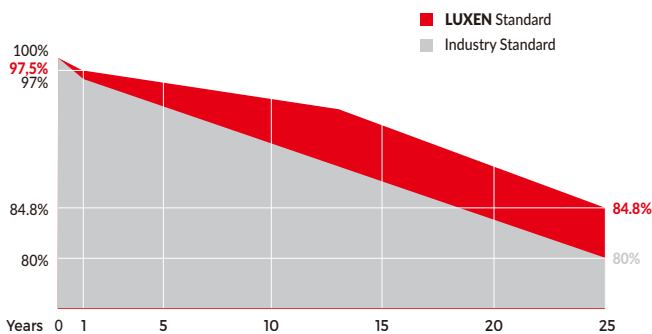

Comprehensive Certificates

- ISO9001:2015 QMS
- ISO14001:2015 EMS
- ISO45001:2018 OHSMS
- IEC61215/IEC61730 Standard quality



MECHANICAL CHARACTERISTICS

Solar Cells	Mono
No. of Cells	144 (6x24)
Dimensions	2279 x 1134 x 35mm
Weight	28.5kgs
Front Glass	3.2mm coated tempered glass
Frame	Anodized aluminium alloy
Junction Box	Ip68 rated (3 by pass diodes)
	4.0mm ²
Output Cables	300mm (+) / 400mm (-)
	Length can be customized
Connectors	Mc4 compatible
Mechanical load test	5400Pa

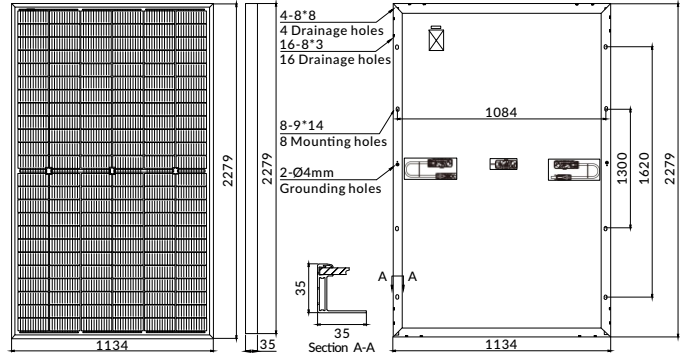

ELECTRICAL PARAMETERS

POWER CLASS	LNVU-530M		LNVU-535M		LNVU-540M		LNVU-545M		LNVU-550M	
	STC	NOCT	STC	NOCT	STC	NOCT	STC	NOCT	STC	NOCT
Maximum power (Pmax)	530W	401W	535W	405W	540W	409W	545W	413W	550W	417W
Open Circuit Voltage (Voc)	49.74V	47.16V	49.89V	47.40V	50.04V	47.63V	50.18V	47.87V	50.32V	48.10V
Short Circuit Current (Isc)	13.62A	10.91A	13.69A	10.95A	13.76A	10.99A	13.83A	11.03A	13.90A	11.07A
Voltage at Maximum power (Vmpp)	41.63V	38.97V	41.80V	39.21V	41.96V	39.44V	42.12V	39.67V	42.28V	39.90V
Current Maximum Power (Impp)	12.73A	10.29A	12.80A	10.33A	12.87A	10.37A	12.94A	10.41A	13.01A	10.45A
MODULE EFFICIENCY (%)	20.51%		20.70%		20.89%		21.09%		21.28%	

STC: Irradiance 1000W/m², cell temperature 25°C, AM1.5G NOCT: Irradiance 800W/m², ambient temperature 20°C, wind speed 1m/s, AM1.5G

PACKING CONFIGURATION

Container	20'GP	40'HQ
Pieces per pallet	31	31
Pallets per container	5	20
Pieces per container	155	620

I-V CURVE

LNVU-540M/I-V

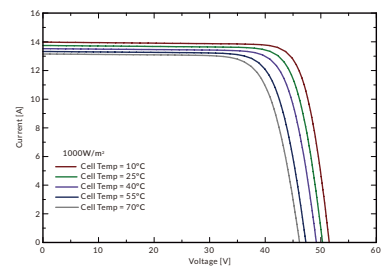
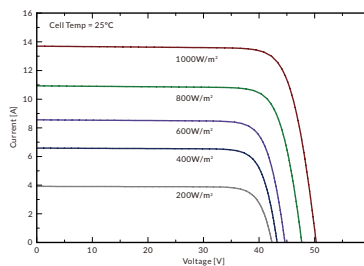

OPERATING CHARACTERISTICS

Operating Module Temperature	-40°C to + 85°C
Maximum System Voltage	1500 DC (IEC)
Maximum Series Fuse Rating	25A
Power Tolerance	0/+5W

TEMPERATURE CHARACTERISTICS

Nominal Operating Temperature (Noct)	45±2°C
Temperature Coefficient of Pmax	-0.36%/°C
Temperature Coefficient of Voc	-0.28%/°C
Temperature Coefficient of Isc	+0.05%/°C

Note: Due to continuous technical innovation, R&D and improvement, technical data above mentioned may be of modification accordingly. LUXEN SOLAR have the sole right to make such modification at anytime without further notice.